



vendas@torquemetal.com.br

Manufatura

Máquinas de última geração e constante busca por novas tecnologias

Produto e Mercado

Nossa equipe está preparada e se mostra flexível, aos mais diversos desafios

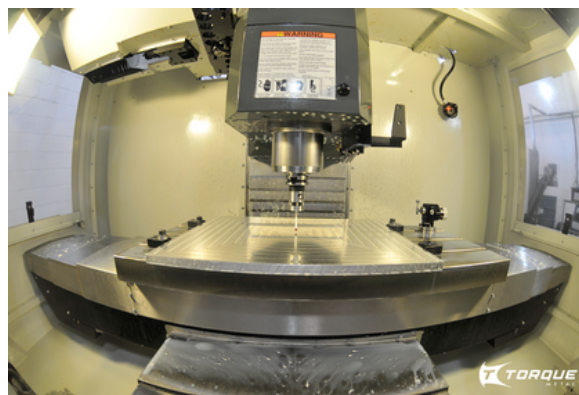

Qualidade

Busca pela excelência em qualidade através de colaboradores comprometidos

Recursos Humanos

Da seleção ao desenvolvimento, nossa estratégia é baseada na competência



PRODUTOS

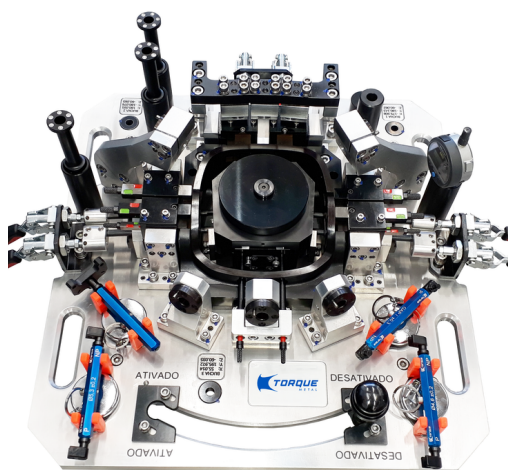

DISPOSITIVOS DE CONTROLE



DISPOSITIVOS DE ELEVAÇÃO

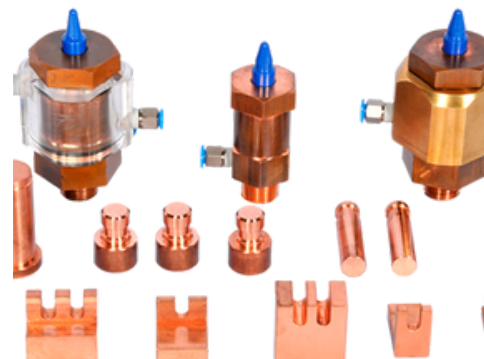

DISPOSITIVOS DE SOLDA

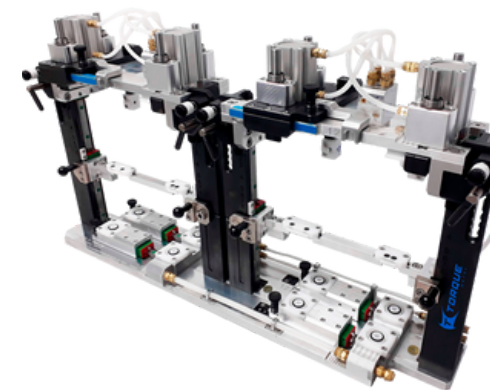

DISPOSITIVOS INDUSTRIAIS

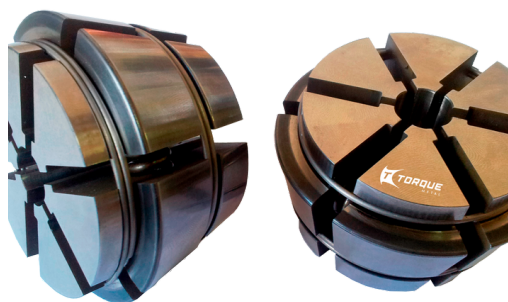

PEÇAS E FERRAMENTARIA



PINOS DE CERÂMICA



RACKS METÁLICOS



LOJA - TORQUE METAL

SOLUÇÕES

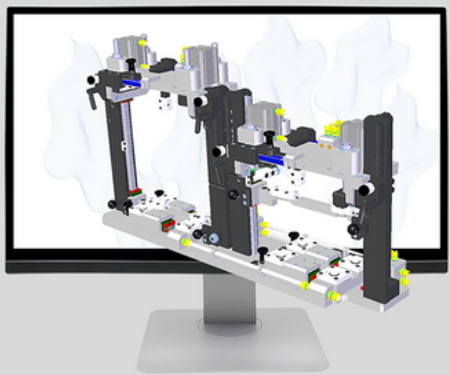

PROJETOS

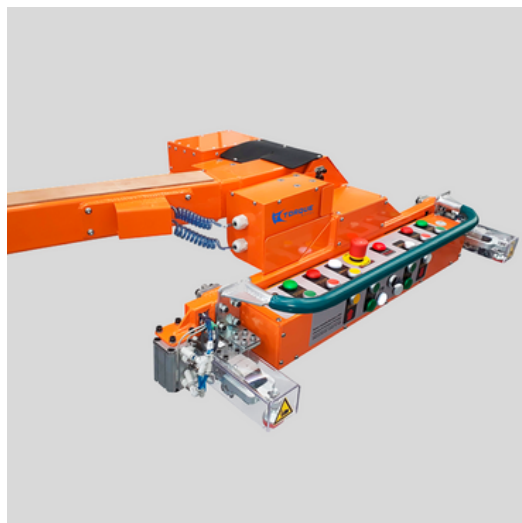

AUTOMAÇÃO



USINAGEM

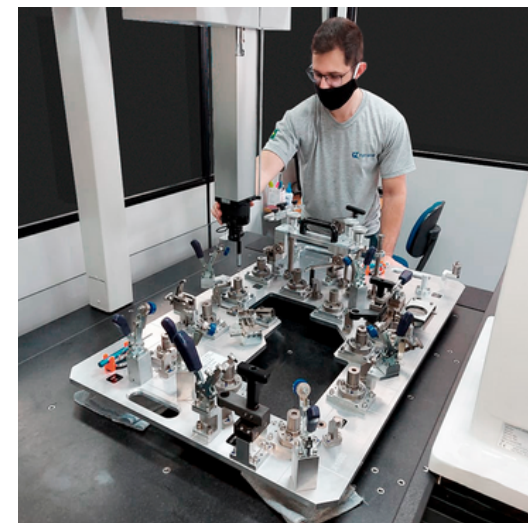

MEDIÇÃO

NOSSA HISTÓRIA

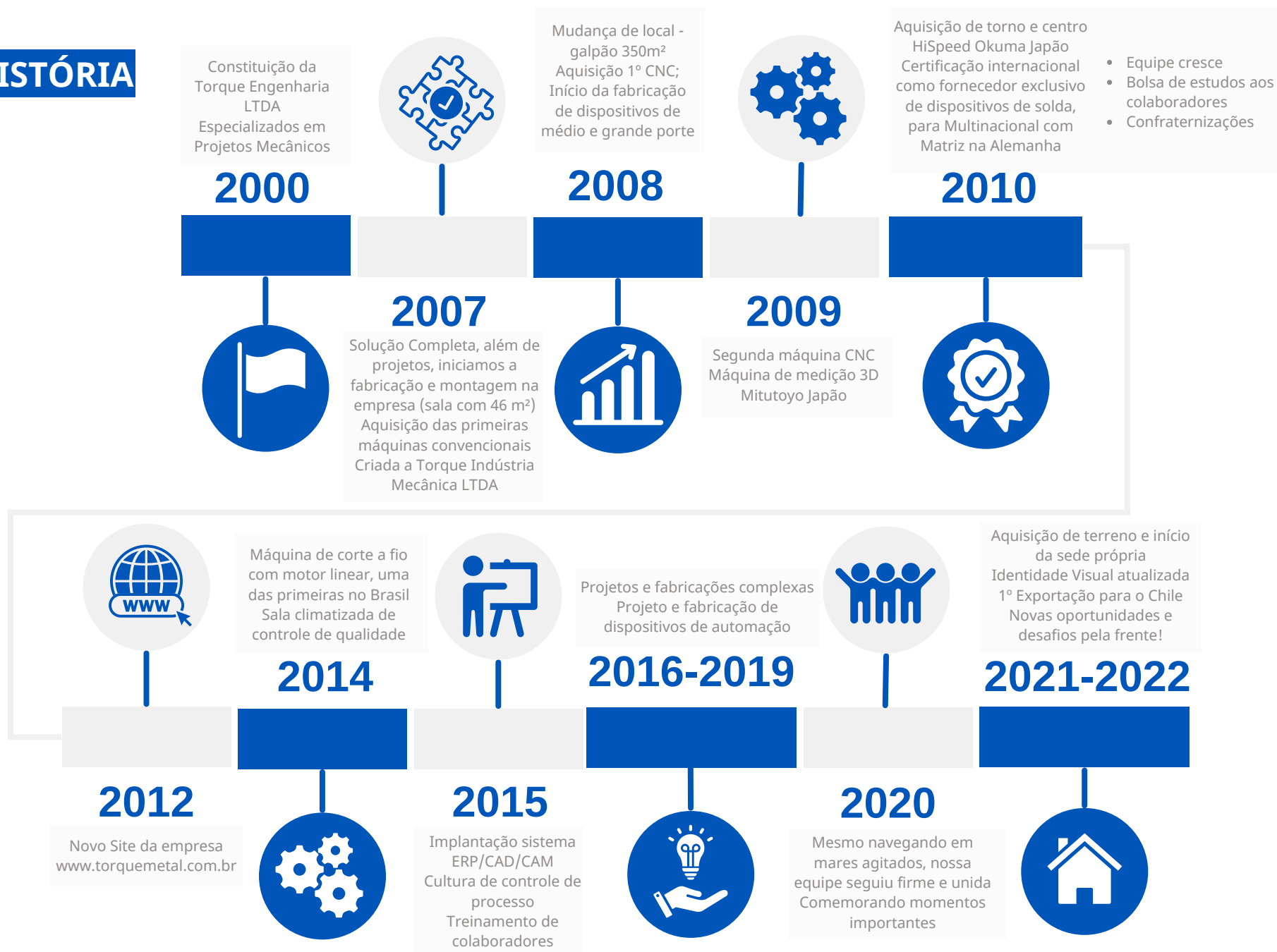



MISSÃO

Oferecer produtos e soluções aos setores: Automotivo, Agrícola e Industrial com Alta Qualidade a um Custo Competitivo.

Líderes em Inovação e Tecnologia.

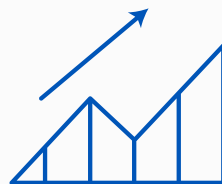

VISÃO

Tornar a empresa reconhecida pela **Qualidade e Confiabilidade** de seus produtos, processos e serviços.



VALORES

Respeito ao ser humano e ao meio ambiente.

Ética, disciplina e pontualidade

Liderança pelo exemplo.

Respeito às leis e regulamentos.

Agir com iniciativa, motivação e espírito de equipe.

Nossa empresa deve ser útil a sociedade.

OBJETIVOS

Ser a primeira opção de compra de nossos clientes;
Desenvolver produtos e processos – Superiores aos de Mercado;
Construir e manter relacionamentos duráveis e de confiança com clientes e fornecedores;
Ser reconhecido pela qualidade e confiabilidade de nossos produtos e processos;
Crescer de forma sustentável e padronizada;

SISTEMA DE GESTÃO TORQUE – SGT

Foco no cliente e em nosso negócio	COMPROMISSO
Qualidade total em nossos produtos e processos	FAZER CERTO DA 1º VEZ
Garantir resultados sustentáveis a longo prazo	MELHORIAS CONTÍNUAS
Seguimento rígido de objetivos e valores da empresa	DISCIPLINA
Investimento em pesquisa e novas tecnologias	INOVAÇÃO

INDICADORES DE RESULTADO

S	SEGURANÇA	Zero acidentes (funcionários e fornecedores)
Q	QUALIDADE	Zero defeito em produtos dos clientes
C	CUSTO	Manter o custo dentro do orçamento
V	VENDAS	Meta de vendas dentro do planejado, sem atrasos na entrega
D	DESENVOLVIMENTO	Desenvolvimento Pessoal e Profissional dos funcionários
I	INOVAÇÃO	Investimento constante em novos processos e tecnologias, melhoria contínua

SEGMENTOS ATENDIDOS

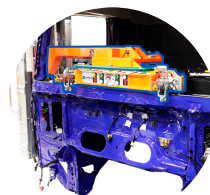

AGROPECUÁRIO



NAÚTICO

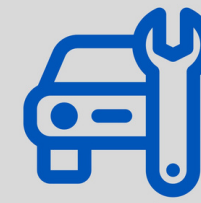

AUTOMOBILÍSTICO



ALIMENTÍCIO



LINHA BRANCA



VEÍCULOS PESADOS



AERONÁUTICO



MOLDES E MATRIZES



MÉDICO



PEÇAS E FERAMENTARIA



GRÁFICA



FARMACÊUTICO



ESTÉTICO

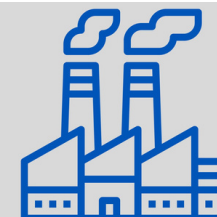

INDUSTRIAL

CLIENTES

VOLVO

TIDEWISE

 **BOSCH**

 **COMP**

 **NEOORTHO**

 **GRAHAM
PACKAGING
COMPANY INC.**

brose
Technik für Automobile

Universidade Estadual
de Ponta Grossa

SANDVIK
Coromant

CNH
INDUSTRIAL

faurecia



ADVANCED CERAMIC SOLUTIONS

DENSO

 **Electrolux**



advaltech

 **NEODENT®**

JTEKT

Continental
The Future in Motion

 **hi**



UTFPR
UNIVERSIDADE TECNOLÓGICA FEDERAL DO PARANÁ

EXÉRCITO BRASILEIRO

Autotec
Fuji Autotech Autopeças do Brasil Ltda.

Stara
Evolução Constante

 **Agres**

 **POSIGRAF**

MÁQUINAS



CENTRO DE USINAGEM OKUMA



FRESA CNC TM - 2P

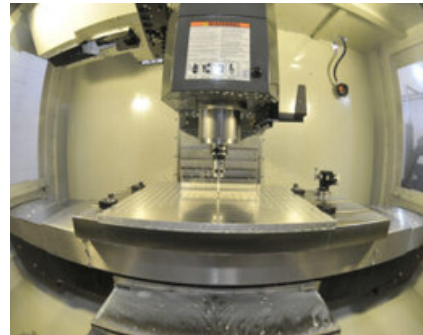

FRESA CNC



TORNO CNC OKUMA



FRESADORA CONVENCIONAL



EROSÃO A FIO MITSUBISHI



RETÍFICA PLANA OKAMOTO



TRIDIMENSIONAL MITUTOYO



FRESA CNC 3 EIXOS TM-2



TORNO CONVENCIONAL

CONTATO

 vendas@torquemetal.com.br

 +55 41 3288-1401